

## Parts List and Wiring Diagrams

### Model PH-44 Headset

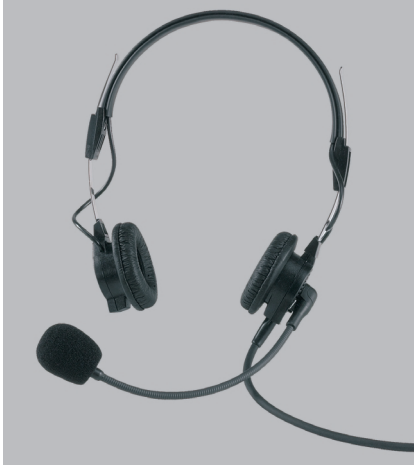

The PH-44 headset is a super lightweight, dual sided headset for the ultimate in day-long comfort. The PH-44 features a high quality dynamic earphones with a dynamic noise cancelling microphone on an adjustable boom that can be bent to practically any mouth-to-mic position. The unit has a straight cord and is available in various connector configurations.

#### Specifications

Receiver Type ..... Dynamic  
 Receiver Impedance ..... 300 ohms  
 Microphone Type ..... Dynamic  
 Microphone Impedance ..... 200 ohms  
 Weight ..... 5.1 ozs  
 Cord ..... 6 ft. straight

### Parts List

ITEM NO.	DESCRIPTION	QTY	PART NO.
1	Windscreen	1	59774-003
2	PT-Pan Head Screw, KA15 x 6(.236) LG., Black	4	590404-360
3	Glider Spring	2	64305-000
4	Housing Assy.	1	64308-106
5	Housing Assy.	1	64308-110
6	Glider Assy.	2	64310-000
7	Cord Amp Assy.	1	64311-054
8	Boom Mic / Housing Assy.	1	800499-001
9	Headband Assy.	1	64352-033
10	Housing, Rear	1	800504-000
11	Ear Cushion	2	590626-000
12	Connector, PH-44, XLR-4F	1	35320-004
	Connector, PH-44R, XLR-4M	1	35398-004
	Connector, PH-44R5, XLR-5M	1	35398-005
	Connector, PH-44A5, XLR-5F	1	35320-005

#### Exploded View

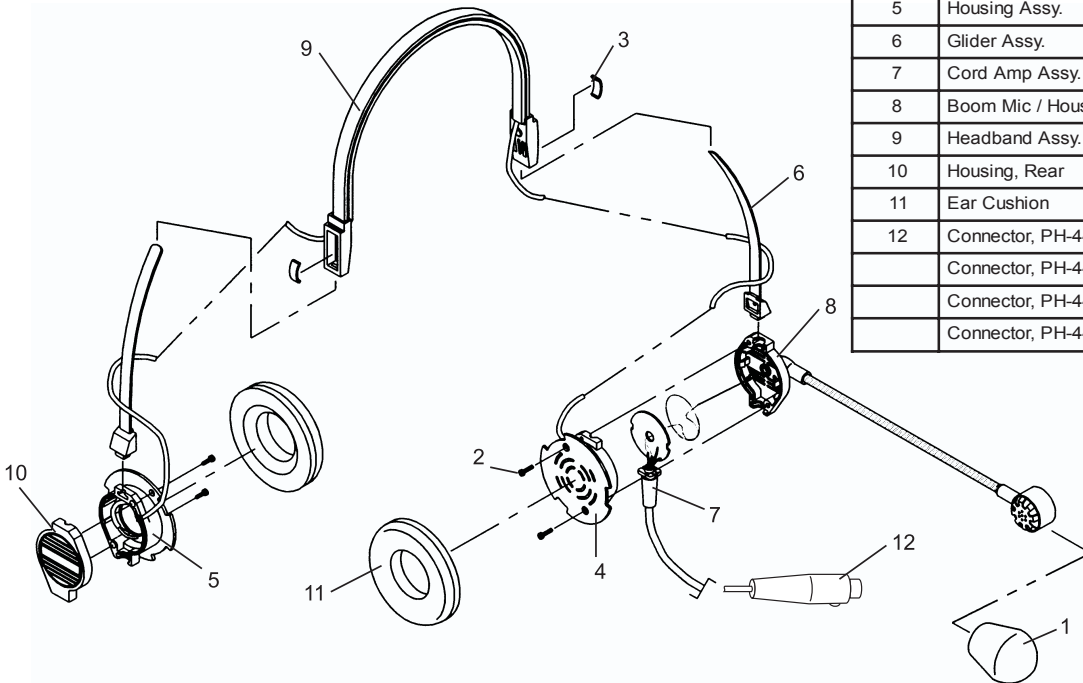

# Wiring Diagram

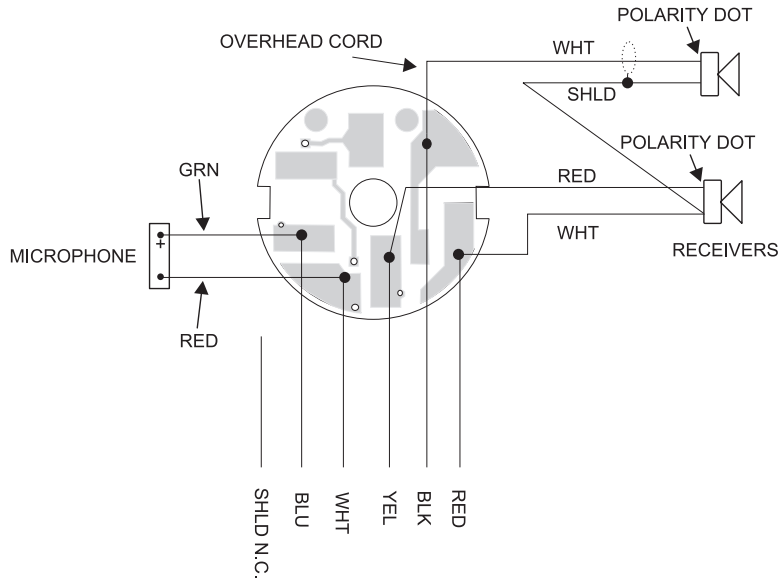

# Connector Wiring

## PH-44

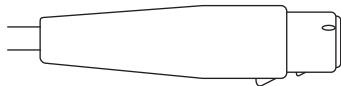

4 Pin Female

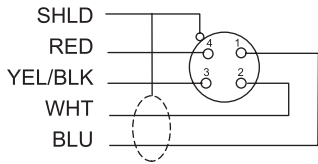

300853-100

## PH-44R

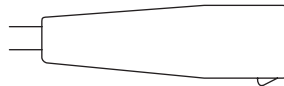

4 Pin Male

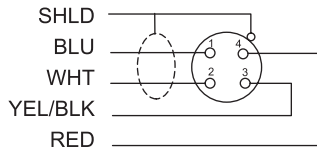

300853-101

## PH-44A5

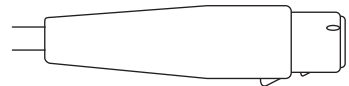

5 Pin Female

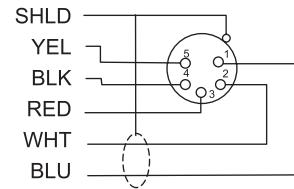

300853-200

## PH-44R5

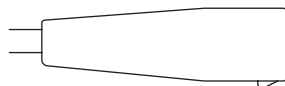

5 Pin Male

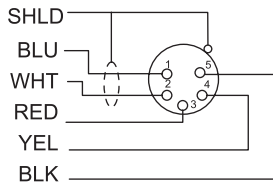

300853-201

